

0.80mm Height Top View  
White Chip LED  
Technical Data Sheet

Part No.: DL-TOP3020W100-02W

# Double Light

## ◆ Features:

1. P-LCC-2 package.
2. White package.
3. Colorless clear window.
4. Wide viewing angle.
5. Suitable for vapor-phase reflow, Infrared reflow and wave solder processes.
6. Compatible with automatic placement equipment.
7. Available on tape and reel (8mm Tape).
8. ESD protection.
9. The product itself will remain within RoHS compliant Version.

## ◆ Descriptions:

1. The 3020 series is available in soft orange, green, blue, and yellow. Due to the package design, the LED has wide viewing angle and optimized. Light coupling by inter reflector. This feature makes the TOP View LEDs ideal for portable equipment or any other application where is at a premium.
2. Double direction zener diode can make the device better against ESD damage.

## ◆ Applications:

1. Automotive: Backlight in dashboards and switches.
2. Telecommunication: Indicator and backlight in telephone and fax.
3. Indicator and backlight for audio and video equipment.
4. Indicator and backlight in office and family equipment.
5. Flat backlight for LCD's, switches and symbols.
6. Light pipe application.
7. General use.

# Double Light

## ◆ Package Dimension:

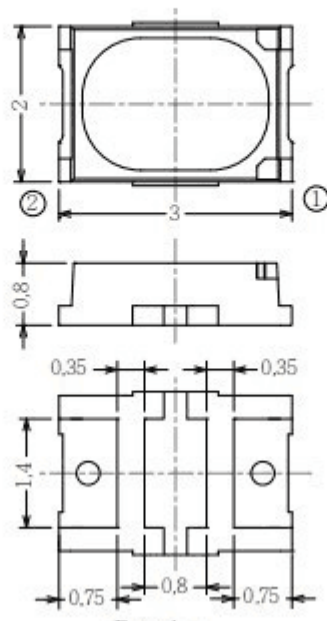

Part No.	Chip Material	Lens Color	Emitting Color
DL-TOP3020W100-02W	InGaN	Yellow Diffused	White

### Notes:

1. All dimensions are in millimeters (inches).
2. Tolerance is  $\pm 0.10\text{mm}$  (.004") unless otherwise specified.
3. Specifications are subject to change without notice.

# Double Light

## ◆ Absolute Maximum Ratings at Ta=25°C

Parameters	Symbol	Max.	Unit
Power Dissipation	PD	200	mW
Peak Forward Current (1/10 Duty Cycle, 0.1ms Pulse Width)	IFP	100	mA
Continuous Forward Current	IF	60	mA
Reverse Voltage	VR	5	V
Electrostatic Discharge (HBM)	ESD	2000	V
Operating Temperature Range	Topr	-40°C to +80°C	
Storage Temperature Range	Tstg	-40°C to +85°C	
Soldering Temperature	Tsld	260°C for 5 Seconds	

## Electrical Optical Characteristics at Ta=25°C

Parameters	Symbol	Min.	Typ.	Max.	Unit	Test Condition
Luminous Flux *	$\Phi_v$	20	---	30	Lm	IF=60mA (Note 1)
Viewing Angle *	$2\theta_{1/2}$	---	120	---	Deg	IF=60mA (Note 2)
Chromaticity Coordinates	X	---	0.30	---		IF=60mA (Note 3)
	Y	---	0.31	---		
Forward Voltage	VF	2.80	3.30	3.80	V	IF=60mA
Reverse Current	IR	---	---	10	$\mu$ A	VR=5V

### Notes:

1. Luminous Intensity Measurement allowance is  $\pm 10\%$ .
2.  $\theta_{1/2}$  is the off-axis angle at which the luminous intensity is half the axial luminous intensity.
3. It use many parameters that correspond to the CIE 1931 2°. X, Y, and Z are CIE 1931 2° values of Red, Green and Blue content of the measurement.

# Double Light

## ◆ Typical Electrical / Optical Characteristics Curves

(25°C Ambient Temperature Unless Otherwise Noted)

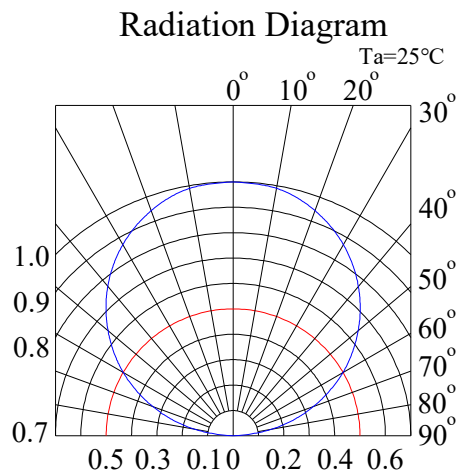
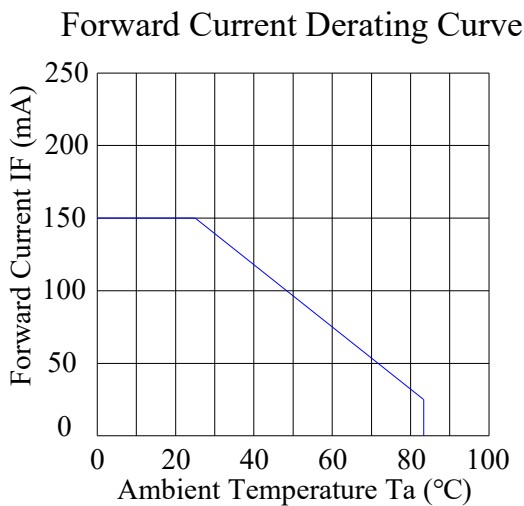
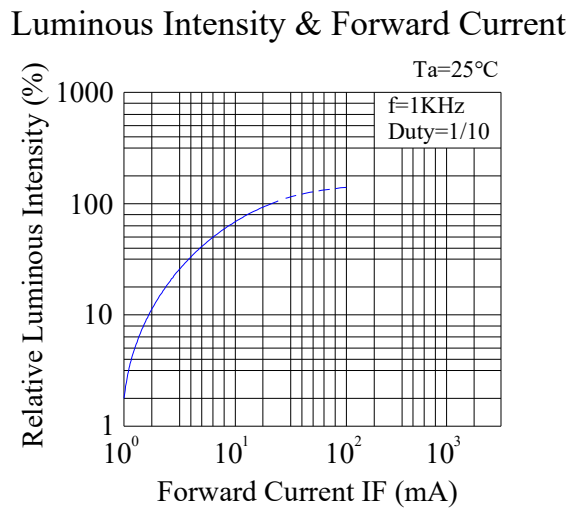
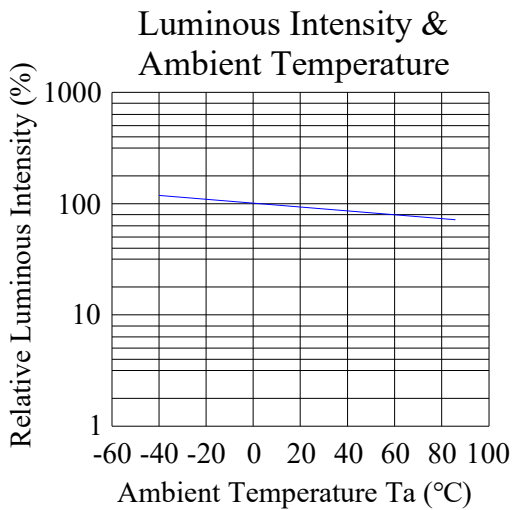
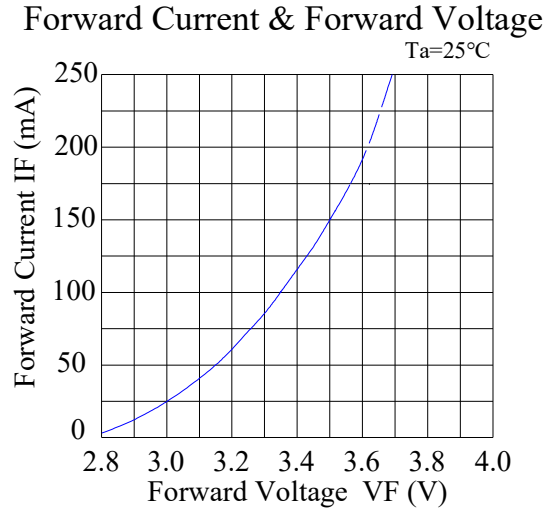
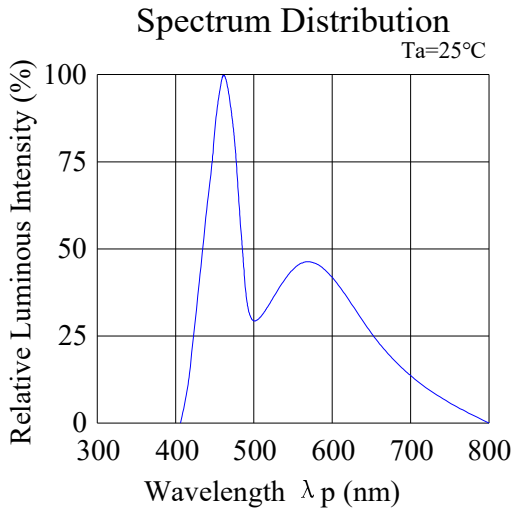

# Double Light

CIE Chromaticity Diagram:

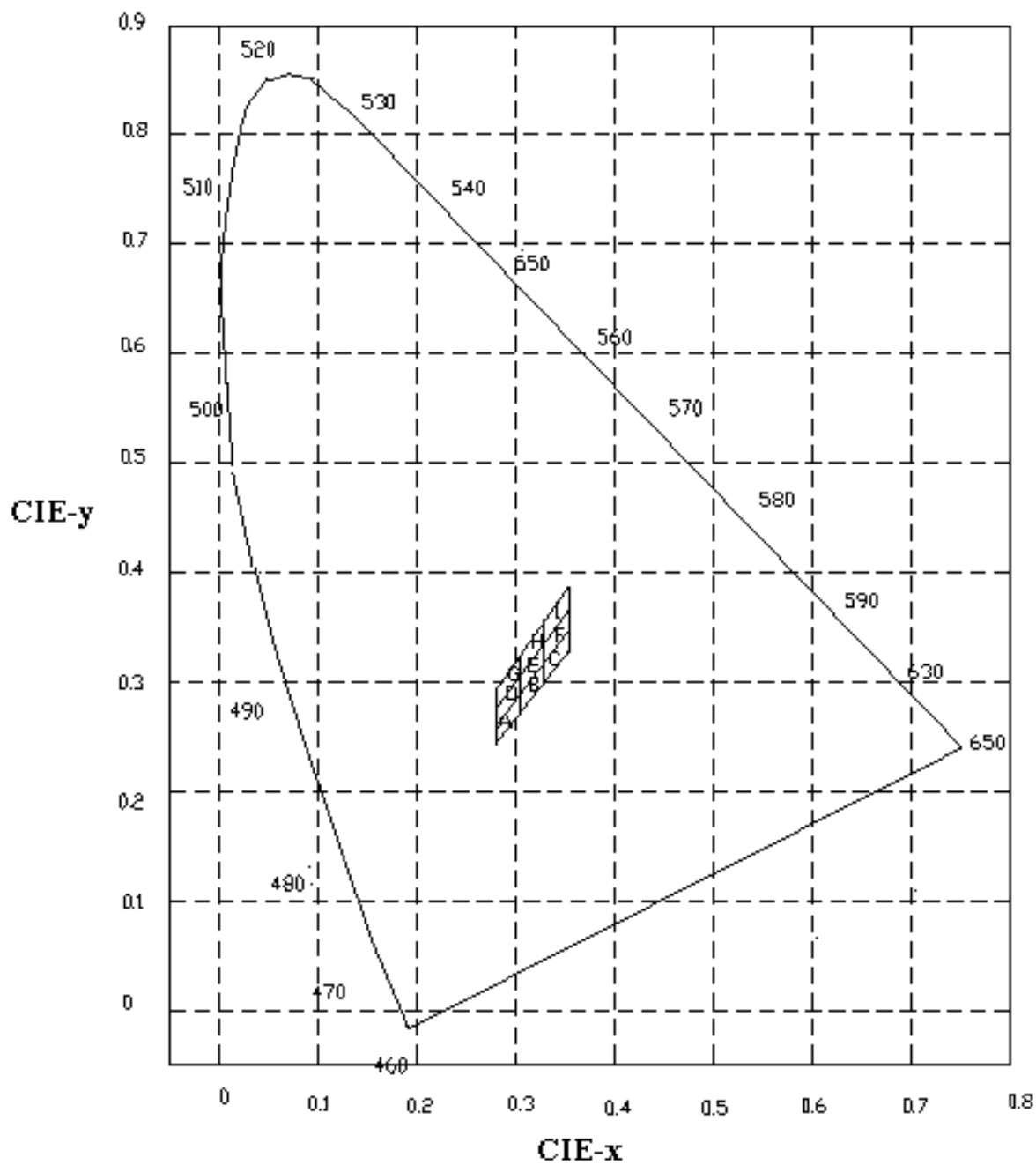

# Double Light

## Chromaticity Coordinates Specifications for Bin Rank

(IF=20mA, Ta=25°C)

Color	Group	Chromaticity Coordinate Group				
White	Full	X	0.270	0.270	0.350	0.350
		Y	0.240	0.290	0.380	0.330
	A	X	0.270	0.270	0.297	0.297
		Y	0.240	0.257	0.287	0.270
	B	X	0.297	0.297	0.323	0.323
		Y	0.270	0.287	0.317	0.300
	C	X	0.323	0.323	0.350	0.350
		Y	0.300	0.317	0.347	0.330
	D	X	0.270	0.270	0.297	0.297
		Y	0.257	0.273	0.303	0.287
	E	X	0.297	0.297	0.323	0.323
		Y	0.287	0.303	0.333	0.317
	F	X	0.323	0.323	0.350	0.350
		Y	0.317	0.333	0.363	0.347
	G	X	0.270	0.270	0.297	0.297
		Y	0.273	0.290	0.320	0.303
	H	X	0.297	0.297	0.323	0.323
		Y	0.303	0.320	0.350	0.333
	I	X	0.323	0.323	0.350	0.350
		Y	0.333	0.350	0.380	0.363

### Notes:

1. Color coordinates measurement allowance is  $\pm 0.01$ .
2. One delivery will include up to two consecutive color ranks and three luminous intensity ranks of the products the quantity-ratio of the ranks is decided by *Doublelight*.

# Double Light

## ◆ Reliability Test Items And Conditions:

The reliability of products shall be satisfied with items listed below:

Confidence level: 90%.

LTPD: 10%.

### 1) Test Items and Results:

No.	Test Item	Test Hours/Cycles	Test Conditions	Sample Size	Ac/Re
1	Resistance to Soldering Heat	6 Min	Tsld=260±5℃, Min. 5sec	25pcs	0/1
2	Thermal Shock	300 Cycles	H: +100℃ 5min J 10 sec L: -10℃ 5min	25pcs	0/1
3	Temperature Cycle	300 Cycles	H: +100℃ 15min J 5min L: -40℃ 15min	25pcs	0/1
4	High Temperature Storage	1000Hrs.	Temp: 100℃	25pcs	0/1
5	DC Operating Life	1000Hrs.	IF=20mA	25pcs	0/1
6	Low Temperature Storage	1000Hrs.	Temp: -40℃	25pcs	0/1
7	High Temperature/ High Humidity	1000Hrs.	85℃/85%RH	25pcs	0/1

### 2) Criteria for Judging the Damage:

Item	Symbol	Test Conditions	Criteria for Judgment	
			Min	Max
Forward Voltage	VF	IF = 20mA	---	F.V.*)×1.1
Reverse Current	IR	VR=5V	---	F.V.*)×2.0
Luminous Intensity	IV	IF = 20mA	F.V.*)×0.7	---

\*) F.V.: First Value.



# Double Light

## ◆ Reel Dimensions:

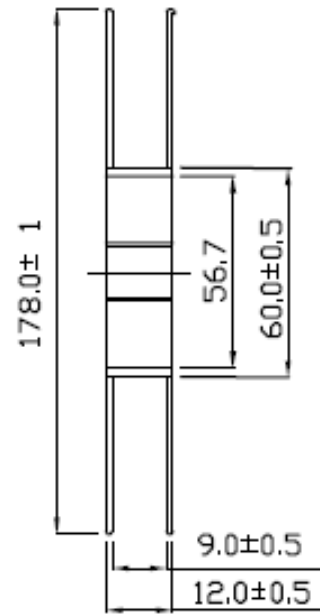
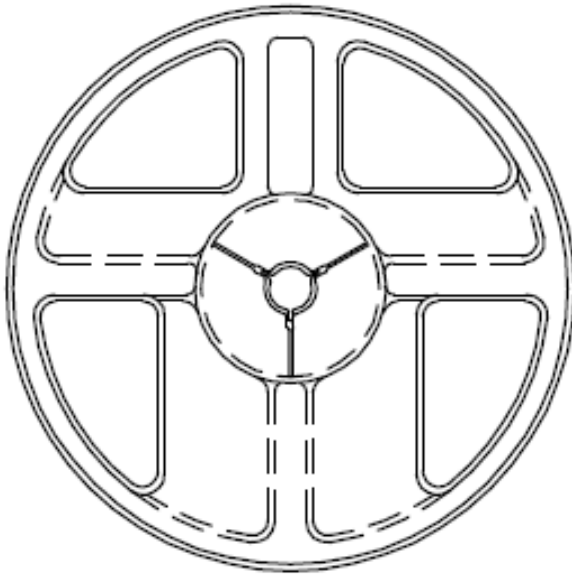

## Carrier Tape Dimensions:

Loaded quantity 3000 PCS per reel.

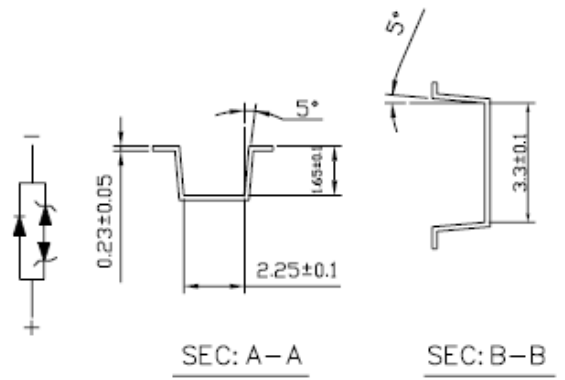
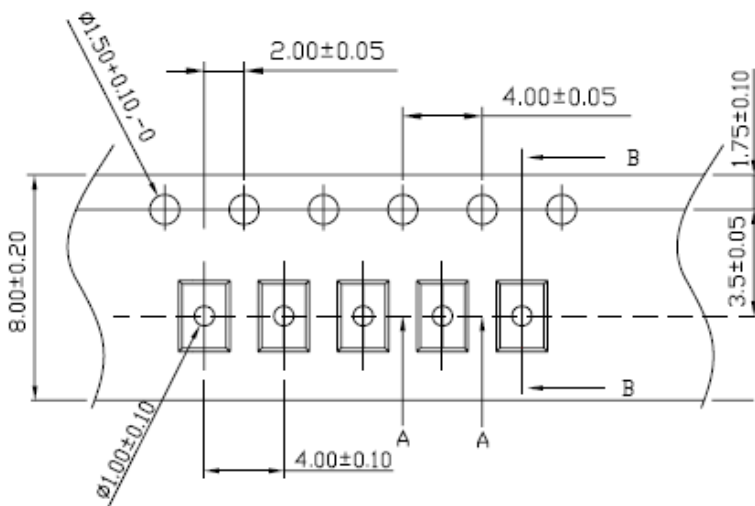

# Double Light

## ◆ Please read the following notes before using the product:

### 1. Over-current-proof

Customer must apply resistors for protection, otherwise slight voltage shift will cause big current change (Burn out will happen).

### 2. Storage

2.1 Do not open moisture proof bag before the products are ready to use.

2.2 Before opening the package, the LEDs should be kept at 30°C or less and 90%RH or less.

2.3 The LEDs should be used within a year.

2.4 After opening the package, the LEDs should be kept at 30°C or less and 70%RH or less.

2.5 The LEDs should be used within 168 hours (7 days) after opening the package.

2.6 If the moisture adsorbent material (silica gel) has fabled away or the LEDs have exceeded the storage time, baking treatment should be performed using the following conditions. Baking treatment: 60±5°C for 24 hours.

### 3. Soldering Condition

#### 3.1 Pb-free solder temperature profile.

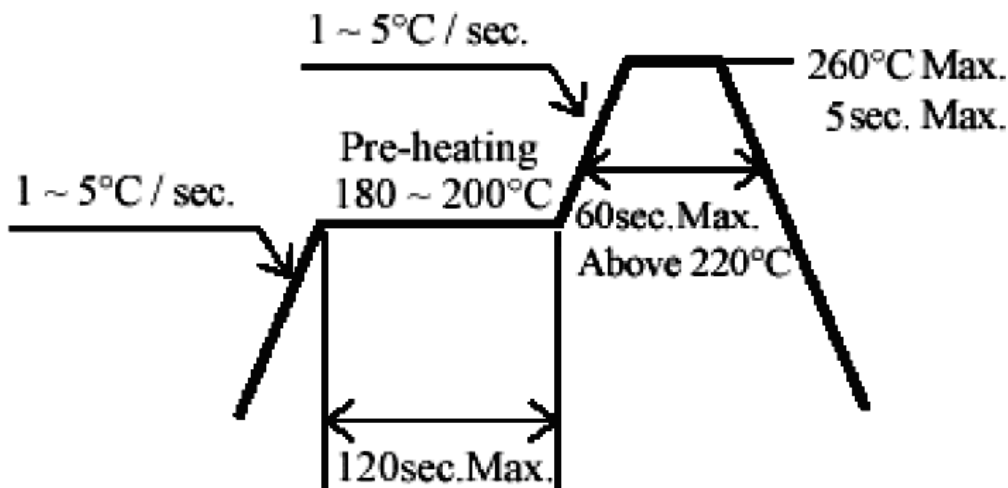

3.2 Reflow soldering should not be done more than two times.

3.3 When soldering, do not put stress on the LEDs during heating.

3.4 After soldering, do not warp the circuit board.

### 4. Soldering Iron

Each terminal is to go to the tip of soldering iron temperature less than 260°C for 5 seconds within once in less than the soldering iron capacity 25W. Leave two seconds and more intervals, and do soldering of each terminal. Be careful because the damage of the product is often started at the time of the hand solder.

### 5. Repairing

Repair should not be done after the LEDs have been soldered. When repairing is unavoidable, a double-head soldering iron should be used (as below figure). It should be confirmed beforehand whether the characteristics of the LEDs will or will not be damaged by repairing.

## Double Light

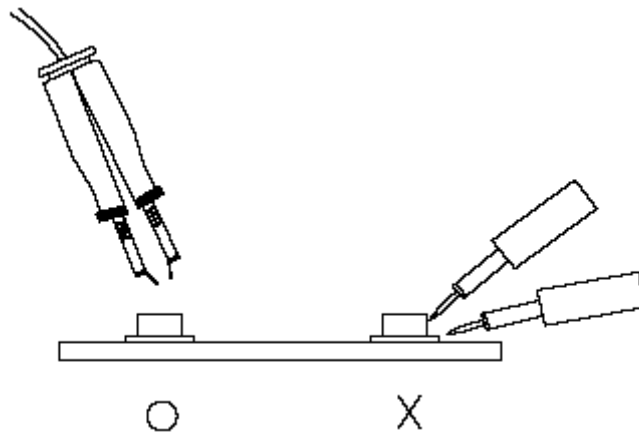

### 6. Caution in ESD

Static Electricity and surge damages the LED. It is recommended to use a wrist band or anti-electrostatic glove when handling the LED. All devices, equipment and machinery must be properly grounded.